



SPECIFICATIONS FOR REFOND SURFACE MOUNT LED

Model: **RF-WNRA50DS-DE**

Company Name: _____

Confirmed By
Customer: _____

DATE: _____

深圳市瑞豐光電子有限公司

SHENZHEN REFOND OPTOELECTRONICS CO.,LTD.

深圳市龍華和平西路特發高新科技園B2棟
B2 wing, Tefa Tech. Industry, West Heping Road,

Longhua Town, Shenzhen, China P.C:518109

TEL:0755-29675000

FAX:0755-29675111

<http://www.refond-led.com>

Feature

- ◆ Viewing angle:120 deg
- ◆ The materials of the LED dice is InGaN
- ◆ 5.30mm×5.00mm×1.60mm SMT-LED
- ◆ RoHS compliant lead-free soldering compatible

Package Outline

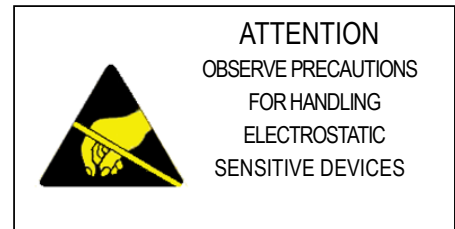
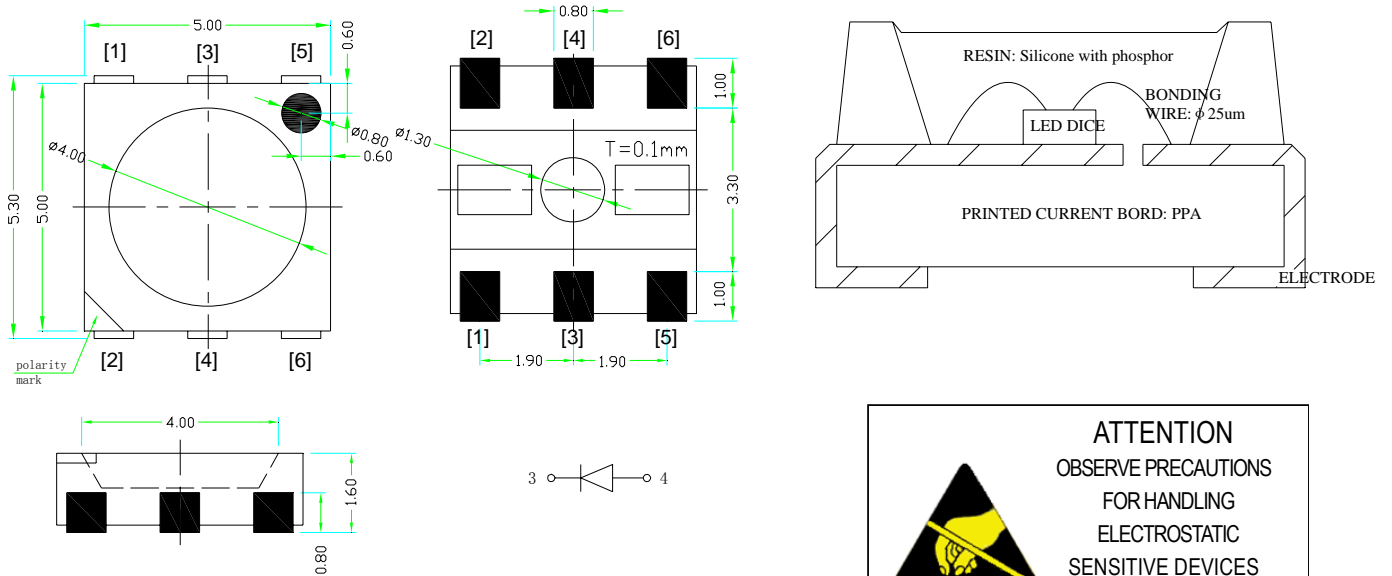

NOTES:

1. All dimensions are in millimeters (inches);
2. Tolerances are $\pm 0.2\text{mm}$ (0.008inch) unless otherwise noted.

APPROVED BY:		CHECKED BY:		PREPARED BY:	
DATE:		DATE:		DATE:	

Absolute maximum ratings at Ta=25°C

Parameter	Symbol	Value	Unit
Power dissipation	Pd	105	mW
Forward current	If	30	mA
Reverse voltage	Vr	5	V
Operating temperature range	Top	-40 ~+100	°C
Storage temperature range	Tstg	-40~+100	°C
Pulse Forward Current	Ifp	100	mA
Electrostatic Discharge	ESD	1000(HBM)	V

Electro-optical characteristics at Ta=25°C

Parameter	Test Condition	Symbol	Value			Unit
			Min.	Typ.	Max.	
Forward voltage	If=20mA	Vf	2.8	--	3.5	V
Luminous intensity	If=20mA	Iv	--	1200	--	mcd
Viewing angle at 50% Iv	If=20mA	2 θ1/2	--	120	--	Deg
Reverse current	Vr=5V	Ir	--	--	10	μA
Chromaticity	If=20mA	A	(0.2613, 0.2292) (0.2468, 0.2361) (0.2663, 0.2746) (0.2779, 0.2618)			
		B	(0.2779, 0.2618) (0.2663, 0.2746) (0.2874, 0.3114) (0.2947, 0.2942)			
		K	(0.2947, 0.2942) (0.2874, 0.3114) (0.3148, 0.3498) (0.3173, 0.3258)			
		L	(0.3173, 0.3258) (0.3148, 0.3498) (0.3331, 0.3756) (0.3352, 0.3509)			

NOTE: (Tolerance: Iv ±10%, λd ±2nm, Vf ±0.05V)

IFP Conditions: Pulse Width ≦ 10msec. and Duty ≦ 1/10.

Typical optical characteristics curves

Spectral Distribution

Relative Intensity vs. Wavelength (Ta=25°C)

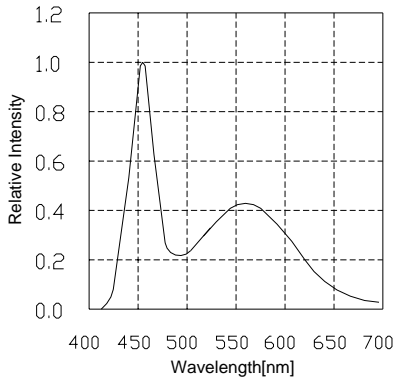

Forward Voltage vs. Forward Current (Ta=25°C)

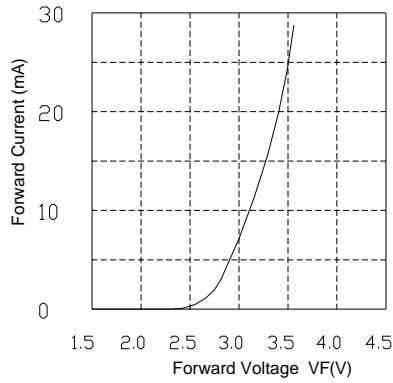

Relative Intensity vs. Forward Current (Ta=25°C)

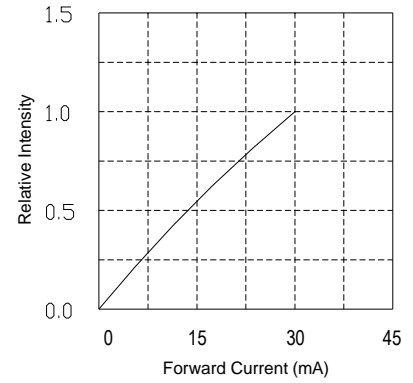

Derating

Relative Intensity vs. Ambient Temperature

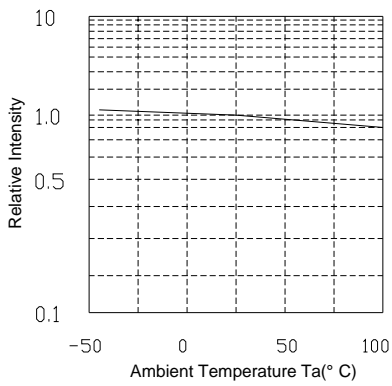

Ambient Temperature vs. Maximum Forward Current

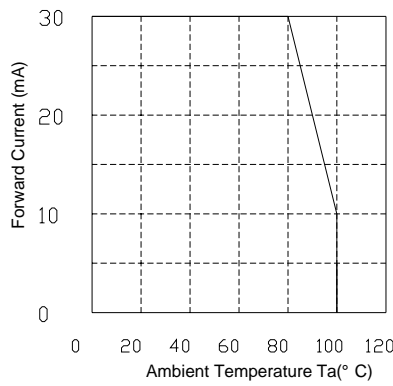

Forward Current vs. Chromaticity (Ta=25°C)

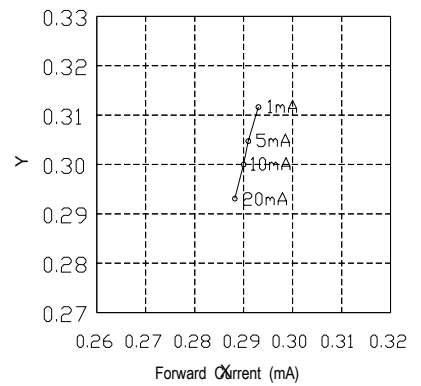
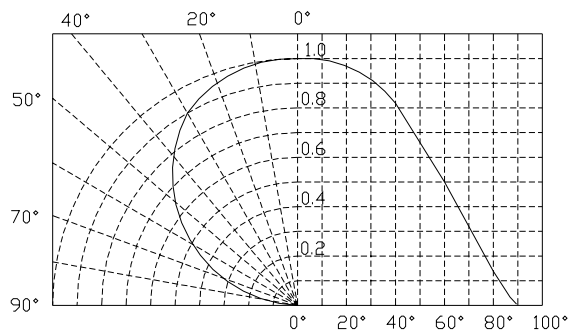

Diagram characteristics of radiation



Reflow profile

■ Soldering condition

- Recommended soldering conditions

Reflow Soldering		Hand Soldering	
Pre-heat	160~180°C	Temperature	300°C Max.
Pre-heat time	120 seconds Max.	Soldering time	3 second Max. (one time only)
Peak temperature	260°C Max.		
Soldering time	10 seconds Max.		
Condition	Refer to Temperature-profile		

- After reflow soldering rapid cooling should be avoided

■ Temperature-profile (Surface of circuit board)

Use the following conditions shown in the figure.

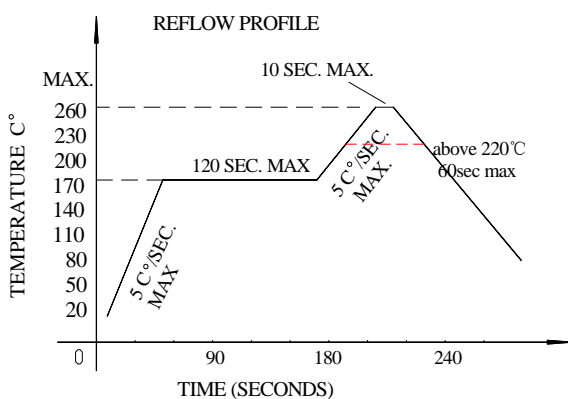

RECOMMEND PAD DESIGN (Units: mm)

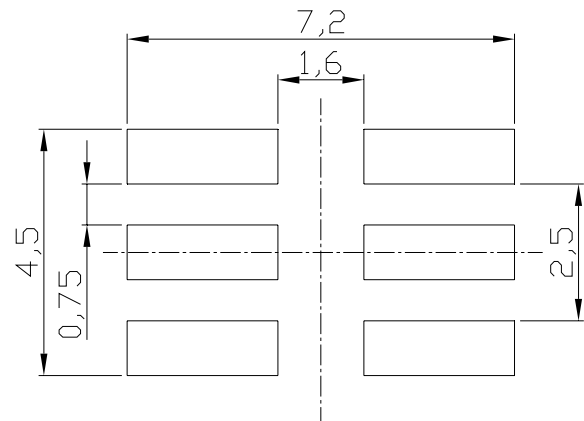

1. Reflow soldering should not be done more than two times
2. When soldering ,do not put stress on the LEDs during heating

■ Soldering iron

1. When hand soldering, keep the temperature of the iron under 300°C, and at that temperature keep the time under 3 sec.
2. The hand soldering should be done only a time
3. The basic spec is ≤ 5 sec. when the temperature of 260°C, do not contact the resin when hand soldering

■ Rework

1. Customer must finish rework within 5 sec under 260°C
2. The head of iron can not touch the resin
3. Twin-head type is preferred.

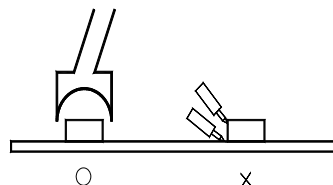

■ CAUTIONS

The encapsulated material of the LEDs is silicone . Therefore the LEDs have a soft surface on the top of package. The pressure to the top surface will be influence to the reliability of the LEDs. Precautions should be taken to avoid the strong pressure on the encapsulated part. So when using the picking up nozzle, the pressure on the silicone resin should be proper.



Reliability

(1) TEST ITEMS AND RESULTS

Type	Test Item	Test Conditions	Note	Number of Damaged
Environmental Sequence	Resistance to Soldering Heat(Reflow Soldering)	Tsld=260°C, 10sec	2 times	0/22
	Temperature Cycle	-40°C 30min ↑↓5min 100°C 30min	100 cycle	0/100
	Thermal Shock	-40°C 15min ↑↓ 100°C 15min	100 cycle	0/100
	High Temperature Storage	T _a =80°C	1000 hrs	0/100
	Temperature Humidity Storage	T _a =60°C RH=90%	1000 hrs	0/100
	Low Temperature Storage	T _a =-30°C	1000 hrs	0/100
	Power On/off Cycle Test IF=20mA	On 2 hours ↑↓ Off 10min	100 cycle	0/100
Operation Sequence	Life Test	T _a =25°C I _F =20mA	1000 hrs	0/100
	High Humidity Heat Life Test	60°C RH=90% I _F =20mA	500 hrs	0/100
	Low Temperature Life Test	T _a =-20°C I _F =20mA	1000 hrs	0/100
	Drop	75cm	3 times	0/10

(2) CRITERIA FOR JUDGING THE DAMAGE

Item	Symbol	Test Conditions	Criteria for Judgement	
			Min.	Max.
Forward Voltage	VF	IF=10mA	-	U.S.L*)×1.1
Reverse Current	IR	VR=5V	-	U.S.L*)×2.0
Luminous Intensity	IV	IF=10mA.	L.S.L**)*×0.7	-

U.S.L.: Upper Standard Level

L.S.L.: Lower Standard Level



REFOND

Packaging Specifications

● Feeding Direction

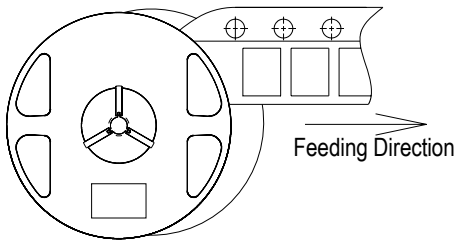

● Dimensions of Reel (Unit: mm)

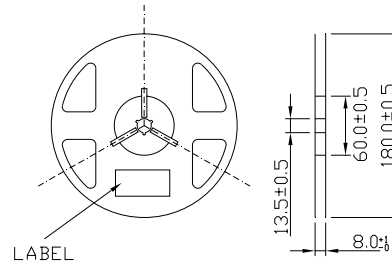

● Dimensions of Tape (Unit: mm)

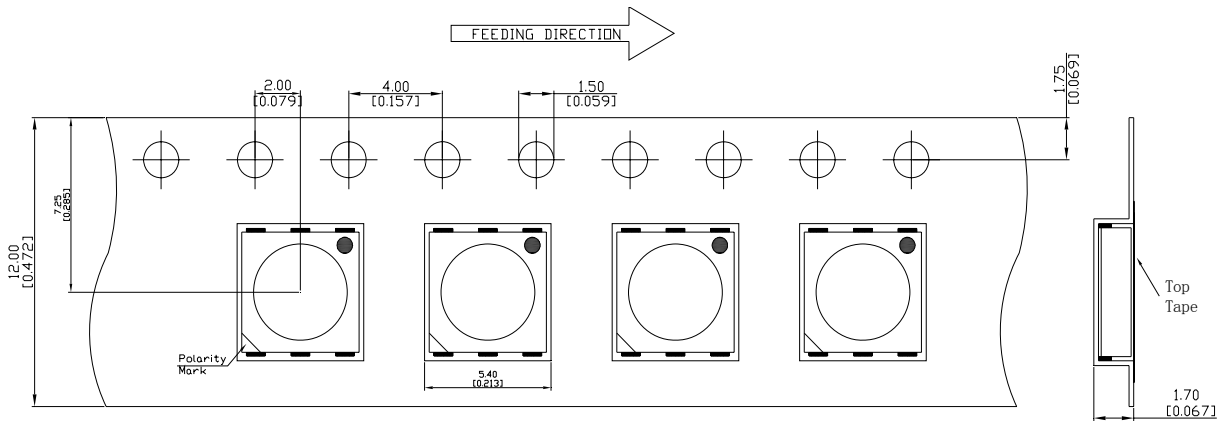

● Arrangement of Tape

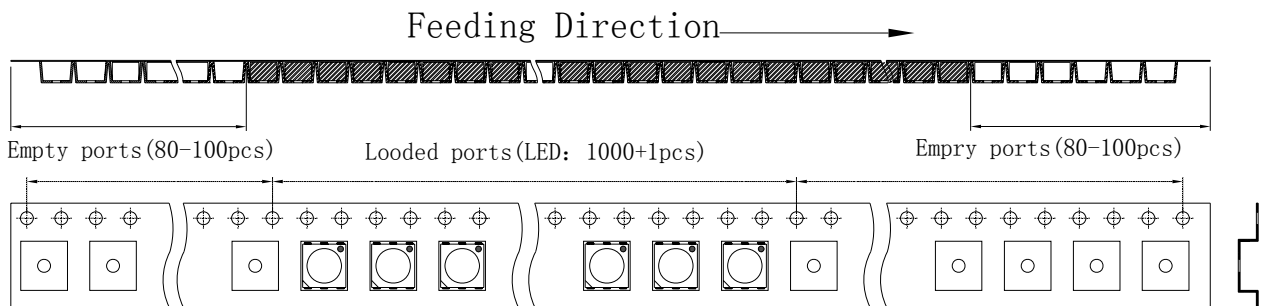



NOTES

1. Empty component pockets are sealed with top cover tape;
2. The maximum number of missing lamps is two;
3. The cathode is oriented towards the tape sprocket hole in accordance with ANSI/EIA RS-481 specifications.
4. 1,000 pcs/ Reel.

Packaging specifications



Label

PART NO.	
LOT NO.	
	
QTY:	PCS
DATE:	
	

CAUTIONS

Package specifications

Reeled products (numbers of products are 1,000pcs) packed in a seal off moisture-proof bag along with a desiccant one by one, Four moisture-proof bag of maximums (total maximum number of products are 4,000pcs) packed in an inside box (size: about 250mm x about 250 x about 68mm) and Five inside boxes of maximums are put the outside box (size: about 360mm x about 265mm x about 255mm) Together with buffer material, and it is packed. (Part No., Lot No., quantity should appear on the label on the moisture-proof bag, part No. And quantity should appear on the label on the cardboard box.) The number of the loading steps of outside box (cardboard box) has three steps.

Storage conditions

Before opening the package:

The LEDs should be kept at 30°C or less and 90%RH or less. The LEDs should be used within a year. When storing the LEDs, moisture proof packaging with absorbent material (silica gel) is recommended.

After opening the package:

The LEDs should be kept at 30°C or less and 70%RH or less. The LEDs should be soldered within 168 hours (7days) after opening the package. If unused LEDs remain, they should be stored in moisture proof packages, such as sealed containers with packages of moisture absorbent material (silica gel). It is also recommended to return the LEDs to the original moisture proof bag and to reseal the moisture proof bag again.