

PNOZ m0p

pilz

PNOZmulti Modular Safety System

This document is a translation of the original document.

All rights to this documentation are reserved by Pilz GmbH & Co. KG. Copies may be made for internal purposes.

Suggestions and comments for improving this documentation will be gratefully received.

Pilz[®], PIT[®], PMI[®], PNOZ[®], Primo[®], PSEN[®], PSS[®], PVIS[®], SafetyBUS p[®], SafetyEYE[®], SafetyNET p[®], the spirit of safety[®] are registered and protected trademarks of Pilz GmbH & Co. KG in some countries.



SD means Secure Digital.

Contents		Page
Chapter 1 Introduction		
1.1	Validity of documentation	1-1
1.1.1	Retaining the documentation	1-1
1.2	Overview of documentation	1-2
1.3	Definition of symbols	1-3
Chapter 2 Overview		
2.1	Unit structure	2-1
2.1.1	Scope of delivery	2-1
2.1.2	Unit features	2-1
2.1.3	Chip card	2-2
2.2	Front view	2-3
2.2.1	PNOZ m0p	2-3
2.2.2	PNOZ m0p ETH	2-3
2.2.3	Key	2-4
Chapter 3 Safety		
3.1	Intended use	3-1
3.1.1	System requirements	3-1
3.2	Safety regulations	3-2
3.2.1	Use of qualified personnel	3-2
3.2.2	Warranty and liability	3-2
3.2.3	Disposal	3-2
3.2.4	For your safety	3-3
Chapter 4 Function description		
4.1	Unit properties	4-1
4.1.1	Integrated protection mechanisms	4-1
4.1.2	Function description	4-1
4.1.2.1	Operation	4-1
4.1.2.2	Block diagram	4-2
4.1.2.3	Diagnostics	4-2
4.1.2.4	Cascading	4-2
4.1.2.5	Safety mat, muting	4-3
4.1.3	Interfaces	4-3
Chapter 5 Installation		
5.1	General installation guidelines	5-1
5.1.1	Dimensions	5-2
5.2	Connecting the base unit and expansion modules	5-3

Chapter 6 Commissioning		
6.1	General wiring guidelines	6-1
6.2	Ethernet interfaces (only PNOZ m0p ETH)	6-2
6.2.1	RJ45 interfaces ("Ethernet")	6-2
6.2.2	Requirements of the connection cable and connector	6-2
6.2.3	Interface configuration	6-2
6.2.4	RJ45 connection cable	6-3
6.2.5	Process data exchange	6-3
6.3	Preparing for operation	6-5
6.3.1	Function test during commissioning	6-5
6.3.2	Commissioning the PNOZmulti safety system for the first time	6-5
6.3.2.1	Load project from chip card	6-5
6.3.2.2	Load project via integrated interface	6-6
6.3.3	Download modified project to the PNOZmulti safety system	6-6
6.3.3.1	Load modified project from chip card	6-6
6.3.3.2	Load modified project via integrated interface	6-6
6.3.4	Connection	6-7
6.4	Connection example	6-9
Chapter 7 Operation		
7.1	Messages	7-1
7.1.1	Display elements for device diagnostics	7-1
7.1.2	Display elements for the Ethernet connection (only PNOZ m0p ETH)	7-2
7.2	Reset Ethernet connection settings	7-3
Chapter 8 Technical details		
8.1	Technical details	8-1
8.2	Service life graph of output relays	8-5
8.3	Maximum capacitive load C (μF) with load current I (mA) at the semiconductor outputs	8-6
8.4	Order reference	8-7

1 Introduction

1.1 Validity of documentation

This documentation is valid for the product **PNOZ m0p**. It is valid until new documentation is published.

This operating manual explains the function and operation, describes the installation and provides guidelines on how to connect the product .

1.1.1 Retaining the documentation

This documentation is intended for instruction and should be retained for future reference.

1.2 Overview of documentation

1 Introduction

The introduction is designed to familiarise you with the contents, structure and specific order of this manual.

2 Overview

This chapter provides information on the product's most important features.

3 Safety

This chapter must be read as it contains important information on intended use.

4 Function Description

This chapter describes the product's mode of operation.

5 Installation

This chapter explains how to install the product.

6 Commissioning

This chapter describes the product's commissioning and wiring.

7 Operation

This chapter describes how to operate the product and gives tips in the case of a fault.

8 Technical Details

This chapter contains the product's technical details and order reference.

1.3 Definition of symbols

Information that is particularly important is identified as follows:



DANGER!

This warning must be heeded! It warns of a hazardous situation that poses an immediate threat of serious injury and death and indicates preventive measures that can be taken.



WARNING!

This warning must be heeded! It warns of a hazardous situation that could lead to serious injury and death and indicates preventive measures that can be taken.



CAUTION!

This refers to a hazard that can lead to a less serious or minor injury plus material damage, and also provides information on preventive measures that can be taken.



NOTICE

This describes a situation in which the product or devices could be damaged and also provides information on preventive measures that can be taken.



INFORMATION

This gives advice on applications and provides information on special features, as well as highlighting areas within the text that are of particular importance.

1 Introduction

2.1 Unit structure

2.1.1 Scope of delivery

- ▶ Base unit **PNOZ m0p**
- ▶ Terminator 779 110

2.1.2 Unit features

Using the product **PNOZ m0p**:

Base units from the PNOZmulti modular safety system

The product has the following features:

- ▶ Can be configured in the PNOZmulti Configurator
- ▶ Positive-guided relay outputs:
 - 2 safety outputs
Depending on the application, up to PL e of EN ISO 13849-1 and up to SIL CL 3 of EN IEC 62061
- ▶ Semiconductor outputs:
 - 4 safety outputs
Depending on the application, up to PL e of EN ISO 13849-1 and up to SIL CL 3 of EN IEC 62061
 - 1 auxiliary output
- ▶ 4 test pulse outputs
- ▶ 1 cascading input and output; can also be used as a standard output
- ▶ 20 inputs for connecting:
 - E-STOP pushbuttons
 - Two-hand buttons
 - Safety gate limit switches
 - Reset buttons
 - Light beam devices
 - Scanners
 - Enabling switches
 - PSEN
 - Operating mode selector switches
 - Pressure sensitive mats
- ▶ Integrated interface:
 - PNOZ m0p: Serial interface RS 232
 - PNOZ m0p ETH: Ethernet interface
- ▶ Muting function
- ▶ Connectable:
 - 1 fieldbus module on the left
 - 4 expansion modules on the left

2.1 Unit structure

- ▶ LED for:
 - Diagnostics
 - Supply voltage
 - Output circuits
 - Input circuits
- ▶ Monitors shorts across the inputs through test pulse outputs
- ▶ Monitoring of shorts between the safety outputs
- ▶ Plug-in connection terminals (either cage clamp terminal or screw terminal)

2.1.3 Chip card

To be able to use the product you will need a chip card.

Chip cards are available with memories of 8 kByte and 32 kByte. For large-scale projects we recommend the 32 kByte chip card (see Technical Catalogue). Accessories chapter).

2.2 Front view

2.2.1 PNOZ m0p

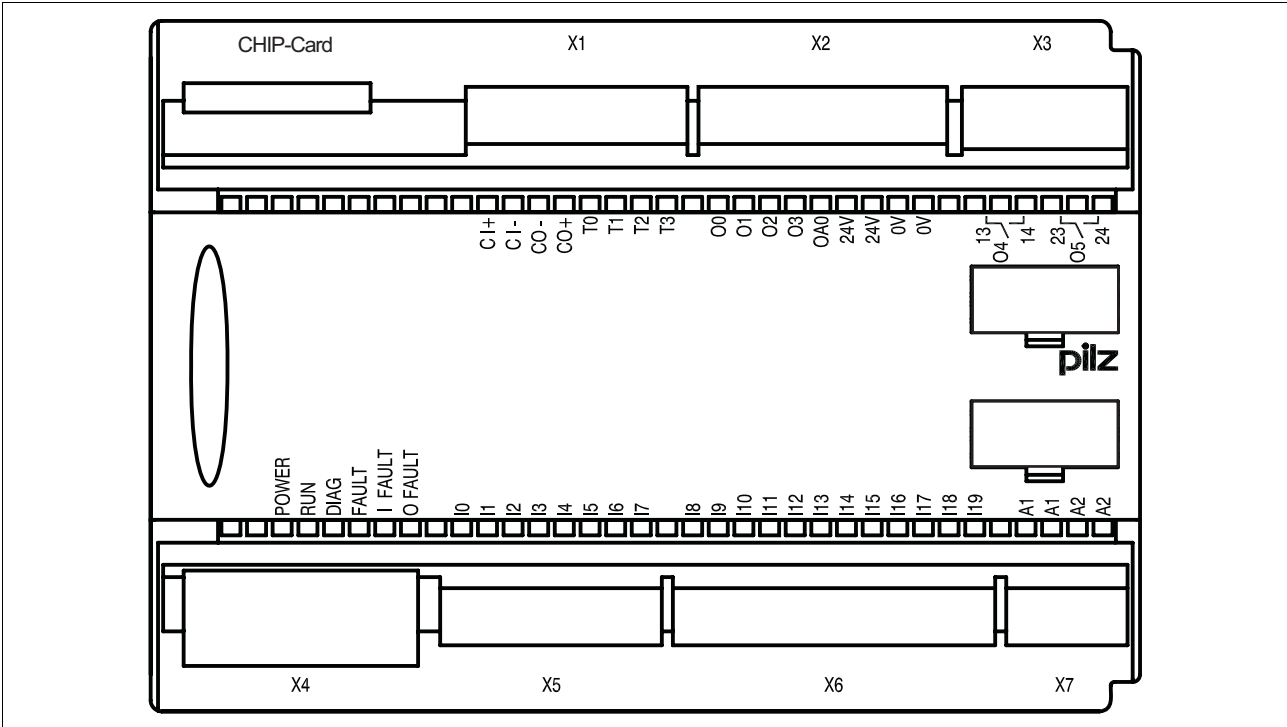

2.2.2 PNOZ m0p ETH

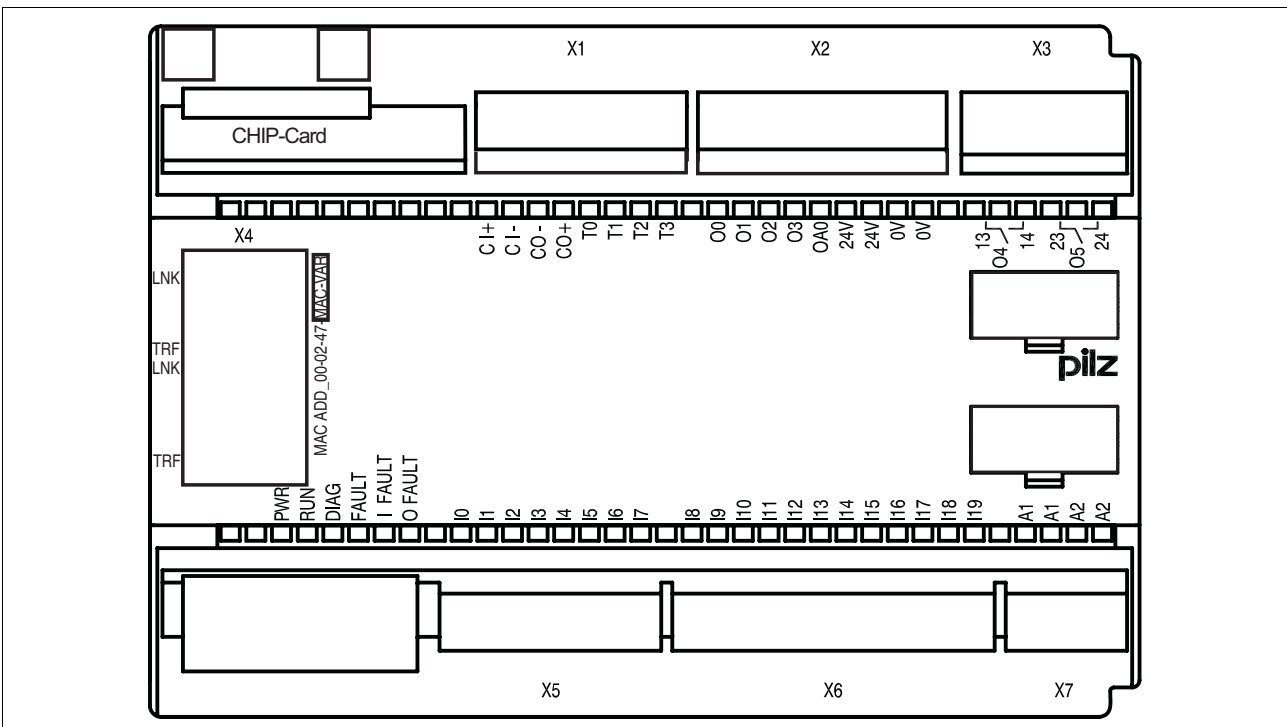

2.2 Front view

2.2.3 Key

Key:

- ▶ CHIP card:
 - Interface chip card
- ▶ X1:
 - Cascading inputs and outputs CI and CO,
 - Test pulse outputs T0 ... T3
- ▶ X2:
 - Semiconductor outputs O0 ... O3,
 - Auxiliary output OA0,
 - Supply connections
- ▶ X3:
 - Relay outputs O4 and O5
- ▶ X4:
 - RJ 232 interface / Ethernet interface
- ▶ X5, X6:
 - Inputs I0 ... I19
- ▶ X7:
 - Power supply
- ▶ LEDs:
 - PWR
 - RUN
 - DIAG
 - FAULT
 - I FAULT
 - O FAULT

3.1 Intended use

The modular safety system PNOZmulti is used for the safety-related interruption of safety circuits and is designed for use on:

- ▶ E-STOP equipment
- ▶ Safety circuits in accordance with VDE 0113 Part 1 and EN 60204-1



CAUTION!

Inputs and outputs for standard functions must not be used for safety-related applications.

Intended use includes making the electrical installation EMC-compliant. The product is designed for use in an industrial environment. It is not suitable for use in a domestic environment, as this can lead to interference.

The following is deemed improper use in particular:

- ▶ Any component, technical or electrical modification to the product
- ▶ Use of the product outside the areas described in this manual
- ▶ Use of the product outside the technical details (see chapter entitled “Technical Details”)

3.1.1 System requirements

- ▶ PNOZmulti Configurator from Version:
 - 4.0.0 (PNOZ m0p)
 - 7.1.0 (PNOZ m0p ETH)

Please contact Pilz if you have an older version.

3.2 Safety regulations

3.2.1 Use of qualified personnel

The products may only be assembled, installed, programmed, commissioned, operated, maintained and decommissioned by competent persons.

A competent person is someone who, because of their training, experience and current professional activity, has the specialist knowledge required to test, assess and operate the work equipment, devices, systems, plant and machinery in accordance with the general standards and guidelines for safety technology.

It is the company's responsibility only to employ personnel who:

- ▶ Are familiar with the basic regulations concerning health and safety / accident prevention
- ▶ Have read and understood the safety guidelines given in this description
- ▶ Have a good knowledge of the generic and specialist standards applicable to the specific application.

3.2.2 Warranty and liability

All claims to warranty and liability will be rendered invalid if:

- ▶ The product was used contrary to the purpose for which it is intended
- ▶ Damage can be attributed to not having followed the guidelines in the manual
- ▶ Operating personnel are not suitably qualified
- ▶ Any type of modification has been made (e.g. exchanging components on the PCB boards, soldering work etc.).

3.2.3 Disposal

- ▶ In safety-related applications, please comply with the mission time t_M in the safety-related characteristic data.
- ▶ When decommissioning, please comply with local regulations regarding the disposal of electronic devices (e.g. Electrical and Electronic Equipment Act).

3.2 Safety regulations

3.2.4 For your safety

The unit meets all necessary conditions for safe operation. However, you should always ensure that the following safety requirements are met:

- ▶ This operating manual only describes the basic functions of the unit. Information on the expanded functions such as cascading can be found in the online help for the PNOZmulti Configurator and in the PNOZmulti technical catalogue. Only use these functions after you have read and understood the documentation. All necessary documentation can be found on the PNOZmulti Configurator CD.
- ▶ Adequate protection must be provided for all inductive consumers.
- ▶ Do not open the housing or make any unauthorised modifications.
- ▶ Please make sure you shut down the supply voltage when performing maintenance work (e.g. exchanging contactors).

4.1 Unit properties

4.1.1 Integrated protection mechanisms

The relay conforms to the following safety criteria:

- ▶ The circuit is redundant with built-in self-monitoring.
- ▶ The safety function remains effective in the case of a component failure.
- ▶ The relay contacts meet the requirements for safe separation through increased insulation compared with all other circuits in the safety system.
- ▶ The safety outputs are tested periodically using a disconnection test.

4.1.2 Function description

4.1.2.1 Operation

The function of the safety system's inputs and outputs depends on the safety circuit created using the PNOZmulti Configurator. A chip card is used to download the safety circuit to the base unit. The base unit has 2 microcontrollers that monitor each other. They evaluate the input circuits on the base unit and expansion modules and switch the outputs on the base unit and expansion modules accordingly.

The LEDs on the base unit and expansion modules indicate the status of the PNOZmulti safety system.

The online help on the PNOZmulti Configurator contains descriptions of the operating modes and all the functions of the PNOZmulti safety system, plus connection examples.

4.1 Unit properties

4.1.2.2 Block diagram

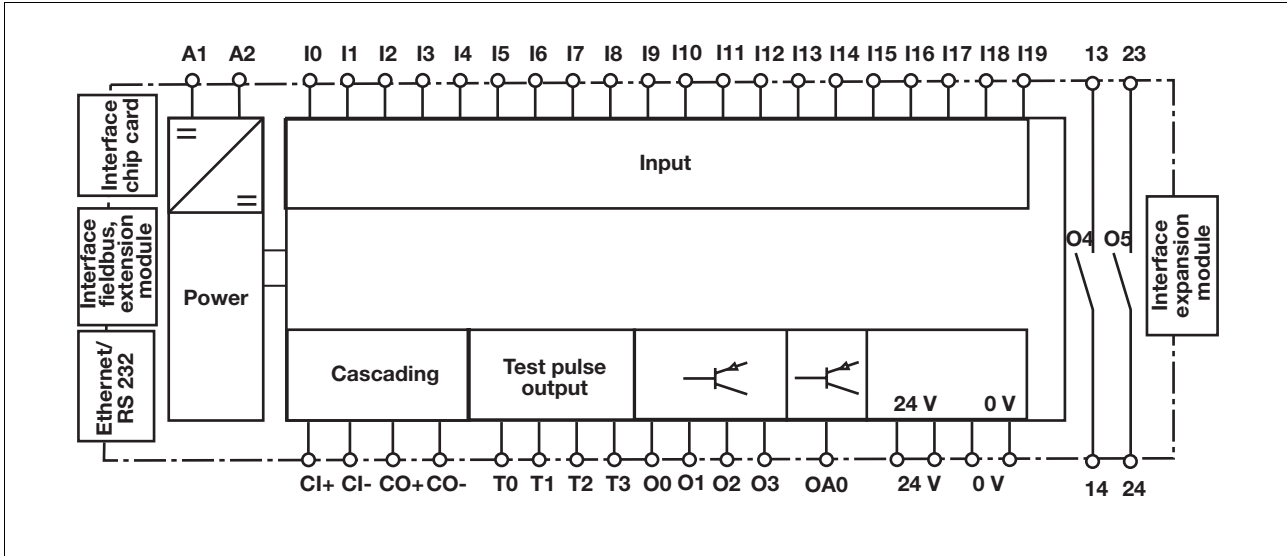

4.1.2.3 Diagnostics

The status and error messages displayed by the LEDs are saved in an error stack. This error stack can be read from the PNOZmulti Configurator via the interfaces (RS 232 or Ethernet). More comprehensive diagnostics are possible via the interfaces or one of the fieldbus modules, e.g. the PROFIBUS module.

4.1.2.4 Cascading

The cascading inputs and outputs enable several PNOZmulti and PNOZelog units to be connected in series or as a tree structure.



INFORMATION

Detailed information on these functions and connection examples can be found in the online help for the PNOZmulti Configurator and in the PNOZmulti technical catalogue.

4.1 Unit properties

4.1.2.5 Safety mat, muting



INFORMATION

Detailed information on these functions and connection examples can be found in the online help for the PNOZmulti Configurator and in the supplement to the "PNOZmulti - special applications" technical catalogue.

4.1.3 Interfaces

The product **PNOZ m0pETH** has two Ethernet interfaces, the product **PNOZ m0p** has one serial interface to

- ▶ Download the project
- ▶ Read the diagnostic data
- ▶ Set virtual inputs for standard functions
- ▶ Read virtual outputs for standard functions.

Information on diagnostics via the interfaces can be found in the Special Applications Technical Catalogue.

The connection to Ethernet is made via the two 8-pin RJ45 sockets. The Ethernet interface is configured in the PNOZmulti Configurator and is described in the online help for the PNOZmulti Configurator.

4 Function description

5.1 General installation guidelines

- ▶ The safety system should be installed in a control cabinet with a protection type of at least IP54. Fit the safety system to a horizontal DIN rail. The venting slots must face upward and downward. Other mounting positions could destroy the safety system.
- ▶ Use the notches on the back of the unit to attach it to a DIN rail. Connect the safety system to the DIN rail in an upright position so that the earthing springs on the safety system are pressed on to the DIN rail.
- ▶ The ambient temperature of the PNOZmulti units in the control cabinet must not exceed the figure stated in the technical details, otherwise air conditioning will be required.
- ▶ To comply with EMC requirements, the DIN rail must have a low impedance connection to the control cabinet housing.

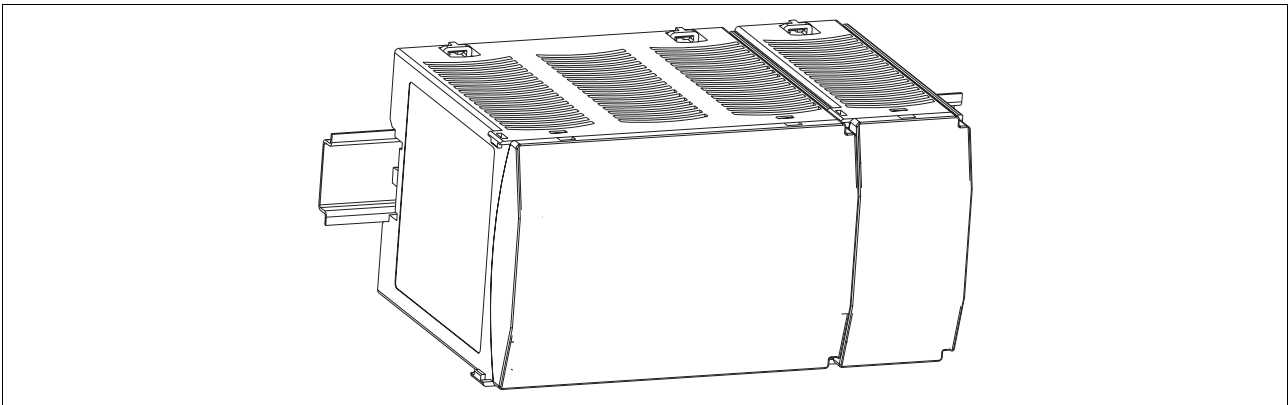

CAUTION!

Damage due to electrostatic discharge!

Electrostatic discharge can damage components. Ensure against discharge before touching the product, e.g. by touching an earthed, conductive surface or by wearing an earthed armband.

5.1 General installation guidelines

5.1.1 Dimensions

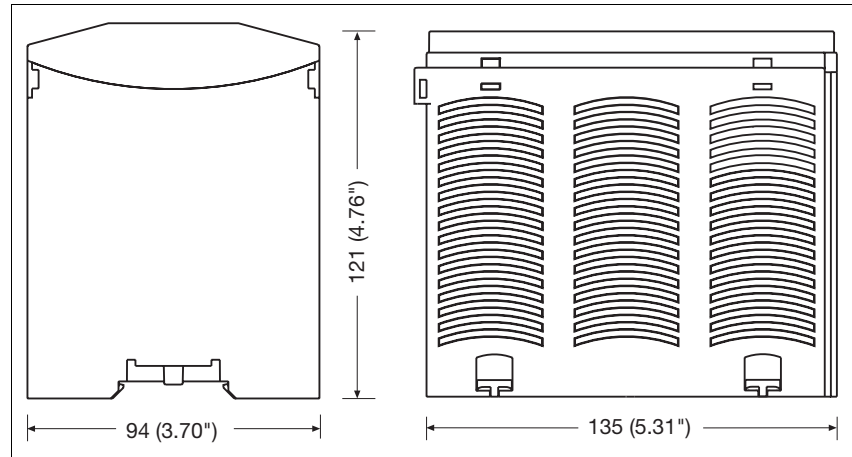

5.2 Connecting the base unit and expansion modules

Jumpers are used to connect the modules.

There are 2 pin connectors on the rear of the base unit.

A max. of 4 expansion modules plus one fieldbus module may be connected to one base unit.

- ▶ Connect the base unit, the expansion modules and the fieldbus module using the jumpers supplied.

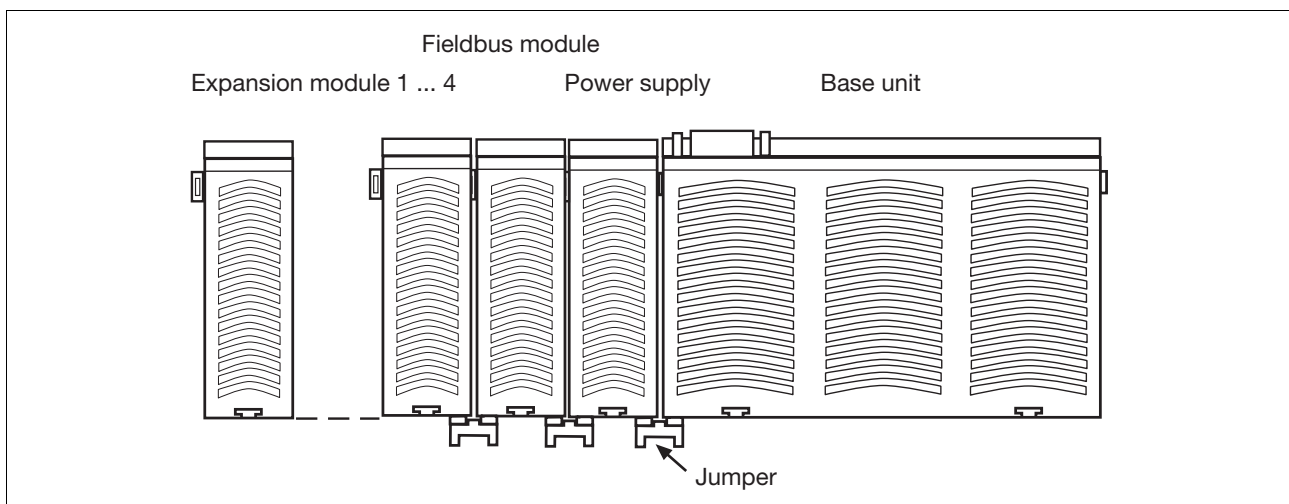

6.1 General wiring guidelines

The wiring is defined in the circuit diagram in the Configurator. There you can select the inputs that are to perform a particular safety function and the outputs that will switch this safety function.

Please note:



CAUTION!

The plug-in connection terminals on the relay outputs that carry mains voltage should only be connected and disconnected when the voltage is switched off.

- ▶ Information given in the “Technical details” must be followed.
- ▶ Outputs:
 - O0 to O5 are safety outputs
 - O4 and O5 are relay outputs
 - O0 to O3 are semiconductor outputs
 - OA0 is an auxiliary output.
- ▶ To prevent contact welding, a fuse should be connected before the output contacts (see technical details).
- ▶ Use copper wire that can withstand 75 °C.
- ▶ Sufficient fuse protection must be provided on all output contacts with inductive loads.
- ▶ Power for the safety system and input circuits must always be provided from a single power supply. The power supply must meet the regulations for extra low voltages with safe separation.
- ▶ Two connection terminals are available for each of the supply connections 24 V and 0 V (semiconductor outputs), plus A1 and A2 (power supply). This means that the supply voltage can be looped through several connections. The current at each terminal may not exceed 3 A.
- ▶ Test pulse outputs must exclusively be used to test the inputs. They must not be used to drive loads.
Do not route the test pulse lines together with actuator cables within an unprotected multicore cable.
- ▶ Test pulse outputs are also used to supply safety mats that trigger a short circuit.
Test pulses that are used for the safety mat may not be reused for other purposes.

6.2 Ethernet interfaces (only PNOZ m0p ETH)

6.2.1 RJ45 interfaces ("Ethernet")

Two free switch ports are provided as Ethernet interfaces via an internal autosensing switch. The autosensing switch automatically detects whether data transfer is occurring at 10 Mbit/s or 100 Mbit/s.

The switch's automatic crossover function means there is no need to distinguish on the connection cable between patch cable (uncrossed data line connection) and crossover cable (crossover data line connection). The switch automatically creates the correct data line connection internally. It is therefore possible to use patch cable as the connection cable for both end devices and cascading.

Both Ethernet interfaces use RJ45 technology.

6.2.2 Requirements of the connection cable and connector

The following minimum requirements must be met:

- ▶ Ethernet standards (min. Category 5) 10BaseT or 100BaseTX
- ▶ Double-shielded twisted pair cable for industrial Ethernet use
- ▶ Shielded RJ45 connectors (industrial connectors)

6.2.3 Interface configuration

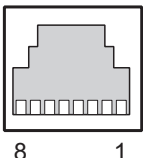
RJ45 socket 8-pin	PIN	Standard	Crossover
	1	TD+ (Transmit+)	RD+ (Receive+)
	2	TD- (Transmit-)	RD- (Receive-)
	3	RD+ (Receive+)	TD+ (Transmit+)
	4	n.c.	n.c.
	5	n.c.	n.c.
	6	RD- (Receive-)	TD- (Transmit-)
	7	n.c.	n.c.
	8	n.c.	n.c.

6.2 Ethernet interfaces (only PNOZ m0p ETH)

6.2.4 RJ45 connection cable

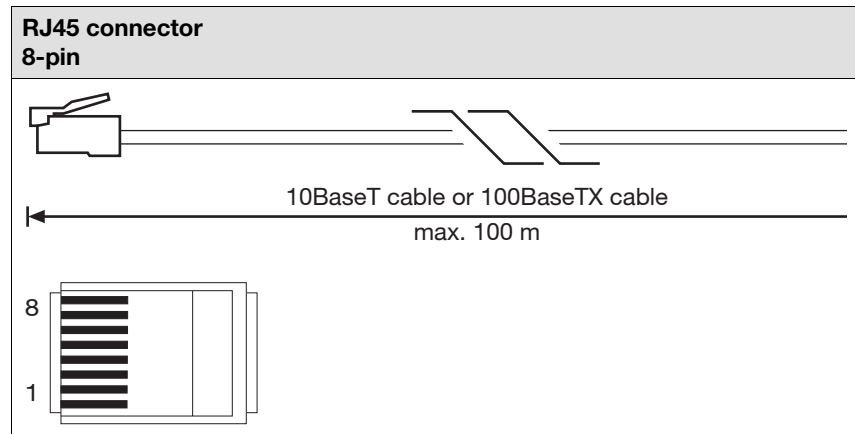

NOTICE

With the plug-in connection please note that the data cable and connector have a limited mechanical load capacity. Appropriate design measures should be used to ensure that the plug-in connection is insensitive to increased mechanical stress (e.g. through shock, vibration). Such measures include fixed routing with strain relief, for example.

6.2.5 Process data exchange

The RJ45 interfaces on the internal autosensing switch enable process data to be exchanged with other Ethernet subscribers within a network.

The product **PNOZ m0pETH** can also be connected to Ethernet via a hub (hub or switch).

6.2 Ethernet interfaces (only PNOZ m0p ETH)

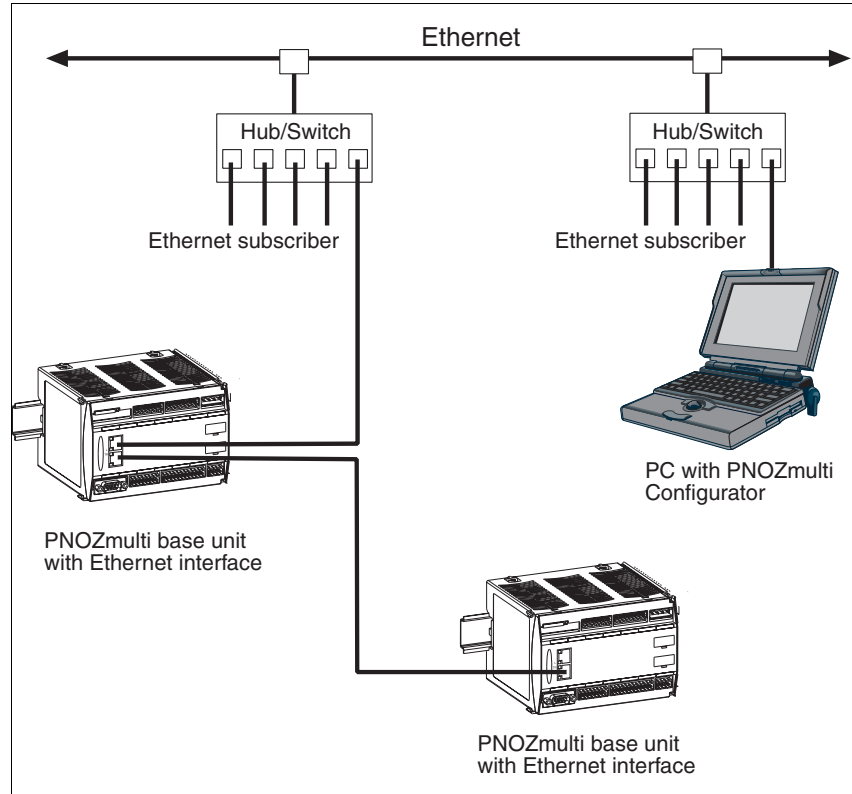

Fig. 6-1: PNOZmulti as Ethernet subscriber - possible topologies

6.3 Preparing for operation

6.3.1 Function test during commissioning



CAUTION!

- It is essential to check that the safety devices operate correctly
- ▶ after the chip card has been exchanged
 - ▶ after a project has been downloaded
 - ▶ when the project has been deleted from the base unit's memory ("Reset Project" menu)

6.3.2 Commissioning the PNOZmulti safety system for the first time

Procedure:

- ▶ Wire the inputs and outputs on the base unit and expansion modules in accordance with the circuit diagram.
- ▶ Cascading output as auxiliary output: Connect the load to CO+ and A2, see connection example.
- ▶ Connect the supply voltage:
 - Supply voltage for the units (connector X7):
 - Terminal A1: + 24 VDC
 - Terminal A2: 0 V
 - Supply voltage for the semiconductor outputs (connector X2):
 - Terminal 24 V: + 24 VDC
 - 0V terminal: 0 V

Note: Supply voltage must always be applied to X2 and X7, even if you are not using the semiconductor outputs.

6.3.2.1 Load project from chip card



NOTICE

Chip contacting is only guaranteed if the contact surface is clean and undamaged. The chip's contact surface should therefore be protected from contamination, contact and mechanical impact such as scratches.

Procedure:

- ▶ Insert the chip card containing the current project into the card slot on the base unit.
- ▶ Switch on the supply voltage.

6.3 Preparing for operation

6.3.2.2 Load project via integrated interface

Procedure:

- ▶ Insert a chip card into the chip card slot on the base unit.
- ▶ Connect the computer containing the PNOZmulti Configurator to the base unit via the interface.
- ▶ Switch on the supply voltage.
- ▶ Download the project (see PNOZmulti Configurator's online help).



INFORMATION

You will need a PC with an Ethernet card in order to establish an Ethernet connection.

6.3.3 Download modified project to the PNOZmulti safety system

6.3.3.1 Load modified project from chip card

To download data via chip card, the existing configuration data must first be deleted (general reset of device).

Procedure:

- ▶ Switch off the supply voltage.
- ▶ Disconnect all the output terminals.
- ▶ Jumper OA0-I19 on the base unit.
- ▶ Switch on the supply voltage.

When the "DIAG" LED on the base unit flashes, the memory has been cleared. The project data can now be downloaded:

- ▶ Switch off the supply voltage.
- ▶ Remove the old chip card from the chip card slot on the base unit.
- ▶ Remove the link from OA0-I19 on the base unit.
- ▶ Insert the chip card containing the current project into the card slot.
- ▶ Switch on the supply voltage.

6.3.3.2 Load modified project via integrated interface

Proceed as described for the initial commissioning

6.3 Preparing for operation

6.3.4 Connection

► Supply voltage

Supply voltage	AC	DC
For the safety system (connector X7)		
For the semiconductor outputs (connector X2) Must always be present, even if the semiconductor outputs are not used		

► Connection examples for the input circuit

Input circuit	Single-channel	Dual-channel
E-STOP without detection of shorts across contacts		
E-STOP with detection of shorts across contacts		

► Connection examples for reset circuit

Reset circuit	Input circuit without detection of shorts across contacts	Input circuit with detection of shorts across contacts

6.3 Preparing for operation

▶ Connection examples for semiconductor outputs

Redundant output		
Single output		

▶ Connection examples for relay outputs

Redundant output		
Single output		

▶ Connection examples for feedback loop

Feedback loop	Redundant output	
Contacts from external contactors		

6.4 Connection example

Dual-channel E-STOP and safety gate wiring, monitored reset (I17), feedback loop (I14), cascading output as auxiliary output (CO+/A2)

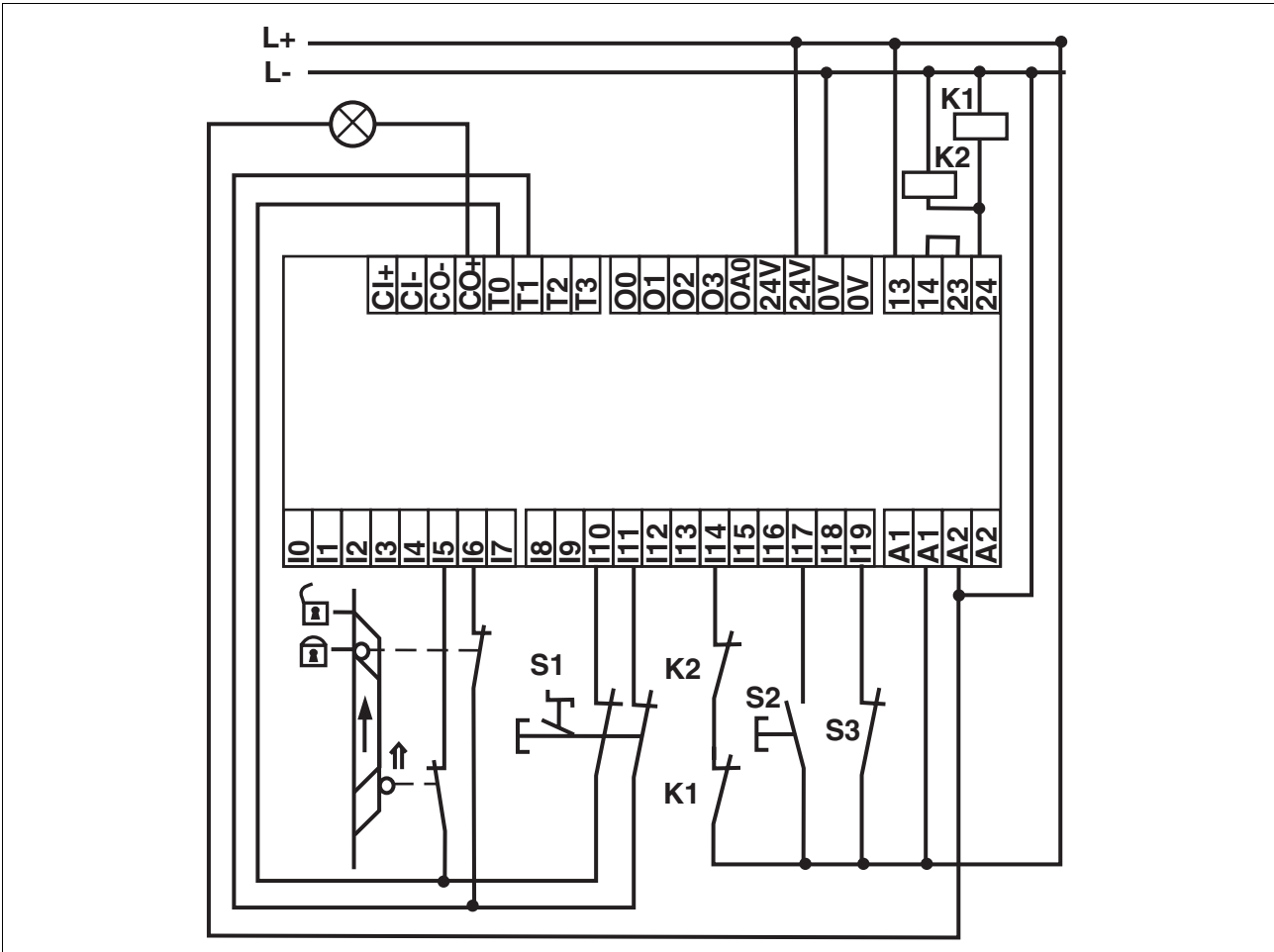

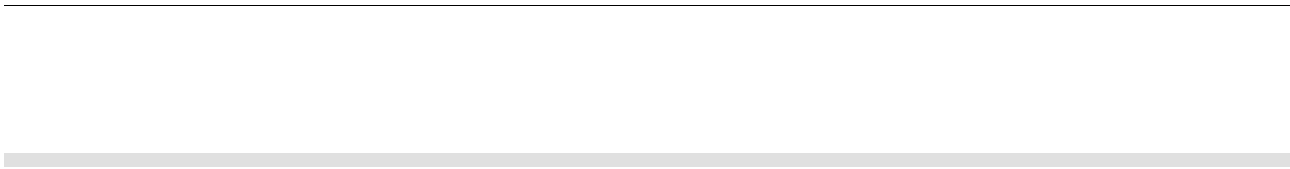

7.1 Messages

The PNOZmulti safety system is ready for operation when the "POWER" and "RUN" LEDs on the base unit are lit continuously.







7.1.1 Display elements for device diagnostics

Key:

	LED on
	LED flashes
	LED off





Basic								Exp.		Errors
Input Ix	RUN	DIAG	FAULT	IFAULT	OFAULT	CI	CO	FAULT	IN/OUT	
	●									The existing user program has been deleted.
	●									External error on the base unit, leading to a safe condition, e.g. terminator not connected.
	●									External error, leading to a safe condition, e.g. short across the contacts or error on safety mat input.
	●									External error on the outputs of the base unit, e.g. short across the contacts, leading to a safe condition.
	●									External error, leading to a safe condition, e.g. short across the contacts.
	●									External error on the output
	●									Internal error on the base unit
	●									Internal error on the base unit
	●									Internal error on the base unit
	●									Internal error on the expansion module
	●									Base unit in a STOP condition
										External error on the inputs of the base unit, which does not lead to a safe condition, e.g. partially operated.
										External error on the outputs of the base unit, which does not lead to a safe condition, e.g. feedback input defective.
										External error on the inputs, which does not lead to a safe condition, e.g. partially operated; feedback input defective.

7.1 Messages

										The fieldbus module has not been recognised. Or The base unit was identified via the PNOZmulti Configurator.
										Error on cascading input; unit remains in a RUN condition.
										Error on cascading output; unit remains in a RUN condition.

7.1.2 Display elements for the Ethernet connection (only PNOZ m0p ETH)

The operating statuses and fault conditions of the Ethernet connection are shown via the LEDs LNK (link) and TRF (traffic) at the Ethernet interfaces.

LED	Signal	Meaning
LNK (green)		No network connection
		Network connection present
TRF (yellow)		No data traffic
		Data traffic present

7.2 Reset Ethernet connection settings

The Ethernet connection settings of the base unit can be configured in the PNOZmulti Configurator.

You can reset the base unit's Ethernet connection settings to the default settings.

Proceed as follows:

- ▶ Switch off the supply voltage
- ▶ Remove the chip card
- ▶ Restart the base unit without the chip card inserted.

The Ethernet connection settings are now reset to the default settings.

8.1 Technical details

Technical details	
Electrical data	
Supply voltage U_B DC	24 V
Voltage tolerance	-15 %/+20 %
Power consumption at U_B DC without load	8.0 W No. 773110 9.0 W No. 773113
per expansion module	2.50 W
Residual ripple DC	5 %
Status display	LED
Times	
Switch-on delay	5.00 s
Simultaneity channel 1/2/3	3 s
Two-hand circuit	0.5 s
Supply interruption before de-energisation	20 ms
Inputs	
Number	20
Max. number of live inputs in the area of max. permitted ambient temperature (see "Environmental data")	$U_B > 26.4 \text{ V} : 15, U_B \leq 26.4 \text{ V} : 20$
Voltage and current at input, reset and feedback circuit	24.0 V, 8.0 mA
Galvanic isolation	no
Signal level at "0"	-3 - +5 V DC
Signal level at "1"	15 - 30 V DC
Min. pulse duration	18 ms
Pulse suppression	0.6 ms
Test pulse outputs	
Number of test pulse outputs	4
Voltage and current, 24 V	0.5 A
Off time during self test	5 ms
Galvanic isolation	no
Short circuit-proof	yes
Semiconductor outputs	
Number	4
Switching capability	
voltage	24 V
current	2 A
power	48 W
Max. capacitive load	1 μF
External supply voltage	24.0 V
Voltage tolerance	-15 %/+20 %
Max. duration of off time during self test	300 μs
Galvanic isolation	yes
Short circuit-proof	yes
Switch-off delay	30 ms
Residual current at "0"	0.5 mA
Signal level at "1"	$U_B - 0.5 \text{ V DC}$ bei 2 A
Relay outputs	
Number	2

8.1 Technical details

Relay outputs	
Utilisation category in accordance with EN 60947-4-1	
Safety contacts: AC1 at 240 V	6.0 A, 1440 VA
Safety contacts: DC1 at 24 V	6.0 A, 144 W
Utilisation category in accordance with EN 60947-5-1	
Safety contacts: AC15 at 230 V	3.0 A, 690 W
Safety contacts: DC13 at 24 V (6 cycles/min)	3.0 A, 72 W
Airgap creepage between	
relay contacts	3 mm
relay contacts and other safe circuits	5.5 mm
External contact fuse protection ($I_K = 1 \text{ kA}$) to EN 60947-5-1	
Blow-out fuse, quick	6 A
Blow-out fuse, slow	6 A
Circuit breaker 24 VAC/DC, characteristic B/C	6 A
Switch-off delay	50 ms
Auxiliary outputs	
Number	1
Switching capability	
voltage	24 V
current	0.5 A
power	12.0 W
Galvanic isolation	yes
Short circuit-proof	yes
Residual current at "0"	0.5 mA
Signal level at "1"	UB - 0.5 V DC bei 0.5 A
Cascading output as auxiliary output	
Number	1
Switching capability	
voltage	24 V
current	0.2 A
power	4.8 W
Galvanic isolation	no
Short circuit-proof	yes
Residual current at "0"	0.5 mA
Environmental data	
EMC	EN 60947-5-1
Vibration to EN 60068-2-6	
Frequency	10 - 55 Hz
Amplitude	0.35 mm
Climatic suitability	EN 60068-2-78
Airgap creepage in accordance with EN 60664-1	
Ambient temperature	0 - 60 °C
Storage temperature	-25 - 70 °C
Mechanical data	
Protection type	
Mounting (e.g. cabinet)	IP54
Housing	IP20
Terminals	IP20
DIN rail	
Top hat rail	35 x 7.5 EN 50022
Recess width	27 mm

8.1 Technical details

Mechanical data	
Maximum cable runs per input	1 km
Sum of individual cable runs at the test pulse output	40 km
Housing material	
Housing	PPO UL 94 V0
Front	ABS UL 94 V0
Cross section of external conductors with screw terminals	
Power supply, inputs, auxiliary output, semiconductor outputs, test pulse outputs, cascading outputs:	
1 core flexible	0.50 - 1.50 mm ² , 22 - 14 AWG No. 773113 0.50 - 2.50 mm ² , 22 - 14 AWG No. 773110
2 core, same cross section, flexible:	
with crimp connectors, without insulating sleeve	0.50 - 0.75 mm ² , 22 - 20 AWG
without crimp connectors or with TWIN crimp connectors	0.50 - 0.75 mm ² , 22 - 20 AWG
Relay outputs:	
1 core flexible	0.5 - 1.5 mm ² No. 773110 0.5 - 2.5 mm ² No. 773113, 22 - 12 AWG
2 core, same cross section, flexible:	
with crimp connectors, without insulating sleeve	0.50 - 1.25 mm ² , 22 - 16 AWG
without crimp connectors or with TWIN crimp connectors	0.50 - 1.25 mm ² , 22 - 16 AWG
Torque setting with screw terminals	0.25 Nm
Cross section of external conductors with spring-loaded terminals: Flexible with/without crimp connectors	0.50 - 1.50 mm ² , 26 - 14 AWG
Spring-loaded terminals: Terminal points per connection	1
Stripping length	9 mm
Dimensions	
Height	94.0 mm
Width	135.0 mm
Depth	121.0 mm
Weight	490 g No. 773110 520 g No. 773113

No. stands for order number.

Safety characteristic data						
Unit	Operating mode	EN ISO 13849-1 PL	EN 954-1 Category	EN IEC 62061 SIL CL	PFH [1/h]	t _M [year]
Logic						
CPU		PL e (Cat. 4)	Cat. 4	SIL CL 3	4.90E-09	20
Input						
SC inputs	single-channel	PL d (Cat. 2)	Cat. 2	SIL CL 2	2.50E-09	20
SC inputs	dual-channel	PL e (Cat. 4)	Cat. 4	SIL CL 3	2.90E-10	20
SC inputs	light beam device	PL e (Cat. 4)	Cat. 4	SIL CL 3	2.50E-10	20
SC inputs	dual-channel pressure sensitive mat	PL d (Cat. 3)	Cat. 3	SIL CL 2	1.81E-09	20
cascading inputs		PL e (Cat. 4)	Cat. 4	SIL CL 3	3.10E-10	20
Output						
SC outputs	single-channel	PL d (Cat. 2)	Cat. 3	SIL CL 2	7.00E-09	20
SC outputs	dual-channel	PL e (Cat. 4)	Cat. 4	SIL CL 3	8.60E-10	20
cascading outputs		PL e (Cat. 4)	Cat. 4	SIL CL 3	4.91E-10	20

8.1 Technical details

Output						
relay outputs	single-channel	PL c (Cat. 1)	Cat. 2	-	2.90E-08	20
relay outputs	dual-channel	PL e (Cat. 4)	Cat. 4	SIL CL 3	3.00E-10	20

Requirement on 1-channel relay outputs for Cat. 2 in accordance with EN 954-1: An additional output switches to a safe condition in the event of an error or, if that is impossible, signals a hazardous condition.

All the units used within a safety function must be considered when calculating the safety characteristic data.

The standards current on **2009-03** apply.



CAUTION!

It is essential to consider the relay's service life graphs. The relay outputs' safety-related characteristic data is only valid if the values in the service life graphs are met.

The PFH value depends on the switching frequency and the load on the relay output. If the service life graphs are not accessible, the stated PFH value can be used irrespective of the switching frequency and the load, as the PFH value already considers the relay's B10d value as well as the failure rates of the other components.

8.2 Service life graph of output relays

The service life graphs indicate the number of cycles from which failures due to wear must be expected. The wear is mainly caused by the electrical load; the mechanical load is negligible.

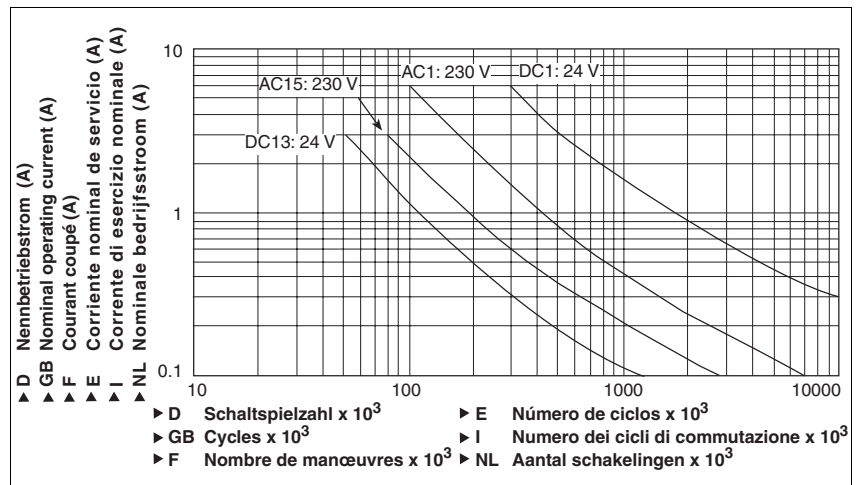

Example

- ▶ Inductive load: 0.2 A
- ▶ Utilisation category: AC15
- ▶ Contact service life: 1 000 000 cycles

Provided the application requires fewer than 1 000 000 cycles, the PFH value (see technical details) can be used in the calculation.

To increase the service life, sufficient spark suppression must be provided on all output contacts. With capacitive loads, any power surges that occur must be noted. With contactors, use freewheel diodes for spark suppression.

We recommend you use semiconductor outputs to switch 24 VDC loads.

8.3 Maximum capacitive load C (mF) with load current I (mA) at the semiconductor outputs

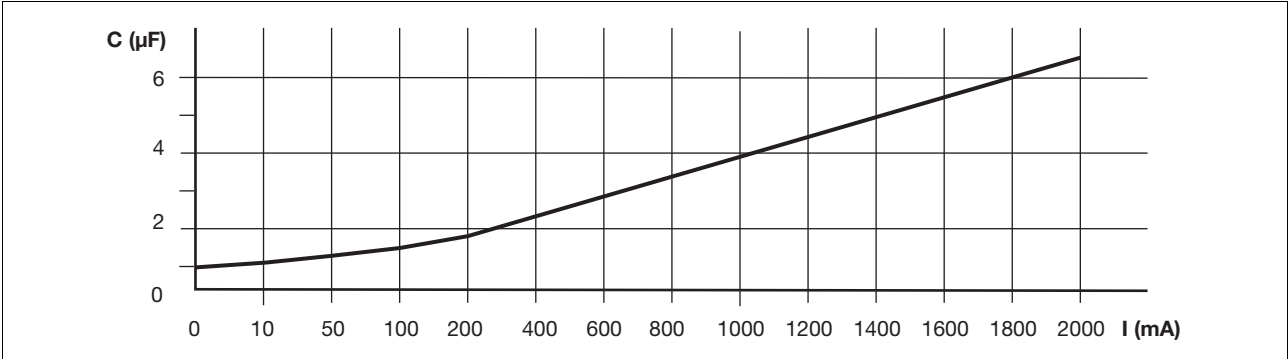

8.4 Order reference

Order reference		
Type	Features	Order no.
PNOZ m0p	Base unit	773 110
PNOZ m0p ETH	Base unit	773 113



DAT - I - 010/05



► ...
In many countries we are represented by our subsidiaries and sales partners.

Please refer to our homepage for further details or contact our headquarters.

Pilz GmbH & Co. KG
Felix-Wankel-Straße 2
73760 Ostfildern, Germany
Telephone: +49 711 3409-0
Telefax: +49 711 3409-133
E-Mail: pilz.gmbh@pilz.de

► **www**
www.pilz.com

► **Technical support**
+49 711 3409-444
support@pilz.com

pilz

InduraneT p®, Pilz®, PIT®, PMCprotego®, PMI®, PNOZ®, Primo®, PSEN®, PSS®, PVIS®, SafetyBUS P®, SafetyEYE®, SafetyNET p®, the spirit of safety® are registered and protected trademarks of Pilz GmbH & Co. KG in some countries. We would point out that product features may vary from the details stated in this document, depending on the status at the time of publication and the scope of the equipment. We accept no responsibility for the validity, accuracy and entirety of the text and graphics presented in this information. Please contact our Technical Support if you have any questions.